

GEARED EYE MANUAL TROLLEY - E-MT-8-C

APPROX WEIGHT: 97.48 lbs.
DOES NOT INCLUDE WEIGHT OF POWER OR PACKAGING!!!

*** ANY ADDITIONS, DELETIONS, OR OMISSIONS MUST BE CORRECTED ON THIS DRAWING AS THIS DRAWING WILL BE CONSIDERED ALL INCLUSIVE ***

ALL GRAPHICS PROVIDED ARE FOR REFERENCE ONLY. IF CERTAIN DIMENSIONS ARE CRITICAL PLEASE VERIFY THOSE DIMENSIONS WITH YOUR SALESPERSON

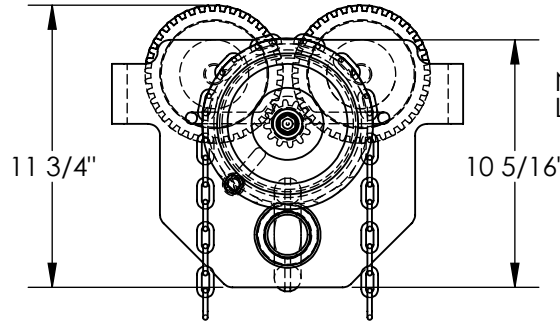
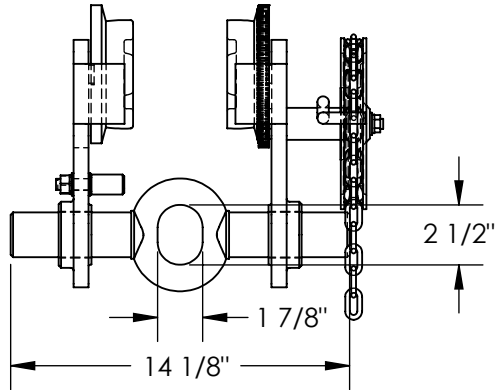
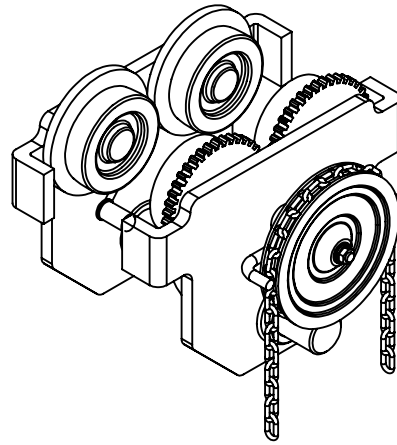
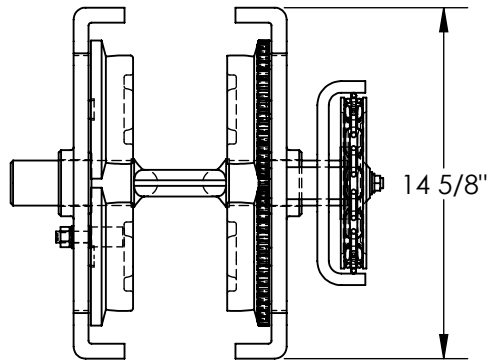

NOTE: FULL CHAIN LENGTH NOT SHOWN

DIMENSION TOLERANCE $\pm 1/4"$

STANDARD FEATURES

- MODEL NUMBER IS E-MT-8-C
- EYE MANUAL TROLLEY
- GEARED LOW PROFILE
- HEADROOM: 8 5/8"
- OVERALL WIDTH IS: 14 1/8"
- OVERALL LENGTH IS: 14 5/8"
- OVERALL HEIGHT IS: 11 3/4"
- MAX CAPACITY IS: 8,000 LBS.
- FITS BEAM FLANGE OF 3" TO 9"
- STEEL CONSTRUCTION WITH PAINTED FINISH
- TROLLEY WIDTH IS ADJUSTABLE BY ROTATING CENTER ROD

NOTE:

CAN BE USED ON S, H, W, & M TYPE I-BEAMS

SPECIAL FEATURES

NONE

APPROVAL	I, THE UNDERSIGNED, AGREE THAT THE PRODUCT AS REPRESENTED SATISFIES DESIGN AND DIMENSION REQUIREMENTS. I ALSO ACKNOWLEDGE MY DUTY TO CONFIRM PRODUCT AND INSTALLATION COMPLIANCE WITH ALL APPLICABLE FEDERAL, STATE AND LOCAL REGULATIONS AND STANDARDS.	
	ANY MODIFIED UNITS ARE NON-RETURNABLE	
	[] As drawn	[] As marked
	Signed: _____	Date: _____
Printed Name: _____		
LEAD TIME WILL START UPON RECEIPT OF SIGNED APPROVAL DRAWING		

FOR INTERNAL USE ONLY PROJECT SIGN OFF	
SALES	
ENG.	
FAB.	
POWER	

DISTRIBUTOR'S NAME:		P.O.#
VESTIL MANUFACTURING		X
DRAWN BY: T. MOORE		W.O.#
DATE: 12/14/09		X
REFERENCE: X	SCALE: 1:8	SALES: X
QUOTED LEAD TIME: X	QUOTE #	FILE NAME:
	X	30-007-134